

96636137 IS S 24L50-730 NR CL1 WS0.3 M60 GY-S

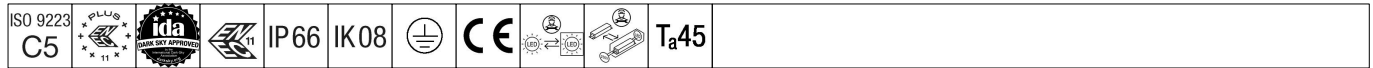

Isaro

A discrete and flexible road and street lantern with durable high performance. Programmable LED driver, set for fixed output, driving 24 LEDs at 500mA. Body: small size, die-cast aluminium (EN AC-44300), powder coated textured Light grey textured (150) - partly painted. Shaft: Light grey textured (150) - partly painted/unpainted. Cover: Extra White glass. Fixings: stainless steel with anti-galvanic treatment. narrow road optic, with Colour Rendering Index min.: 70, Correlated colour temperature*: 3000 Kelvin LEDs supplied. Class I electrical, Impact strength: IK08, IP66, Ta max.: 45°C. Supplied with Ø60mm spigot adaptor which can be fitted for post-top (0°/5°/10° tilt) or side-entry (-20°/-15°/-10°/-5°/0° tilt). Pre-wired with 0.3m, 1.5mm² H07RN-F cable.

Dimensions: 550 x 238 x 157 mm
 Luminaire input power: 36.5 W
 Luminaire luminous flux: 5523 lm
 Luminaire efficacy: 151 lm/W
 Weight: 4.03 kg
 Scx: 0.041 m²



TLG_ISLC_F_S_ZU_SR.jpg

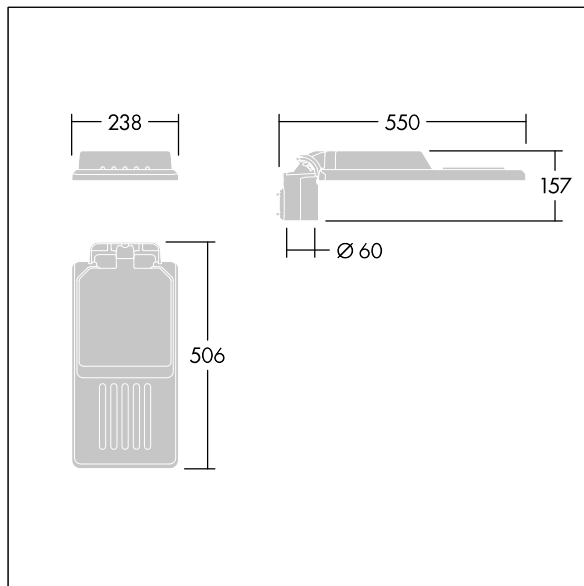

TLG_ISLC_M_SMTp60.wmf

This product contains a light source of energy efficiency class D.

All values marked with an * are rated values. Thorn uses tried and tested components from leading suppliers, however there may be isolated instances of technology-related failures of individual LEDs during the rated product lifetime. International standards set the tolerance in initial flux and connected load at ±10%. Unless stated otherwise, the values apply to an ambient temperature of 25°C.

Isaro

96636137 IS S 24L50-730 NR CL1 WS0.3 M60 GY-S

THORN