

Cetus3

THORN

96634893 CETUS3 L 3000-840 HF RWH

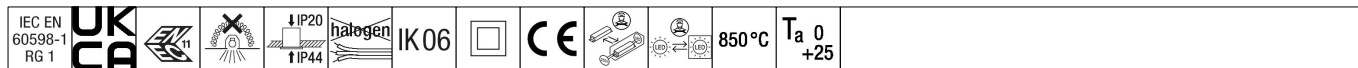

Cetus3

A low height, recessed LED downlight. Suitable for ceiling cut-outs Ø190-230 mm for easy refurbishments or fast initial installations. Remote, pluggable, Fixed output LED driver. Loop in - loop out possible. Body: die-cast aluminium for thermal management. Diffuser: polycarbonate, smooth reflector in white finish with wide beam. Reflector and trim: high quality, highly reflective polycarbonate. Class II electrical (this product is not earthed), IP44_IP20. Spring clips suitable for ceiling thicknesses from 1 to 35 mm. Complete with 4000K LED

Dimensions: Ø248 x 100 mm
 Luminaire input power: 25.4 W
 Luminaire luminous flux: 3463 lm
 Luminaire efficacy: 136 lm/W
 Weight: 0.7 kg

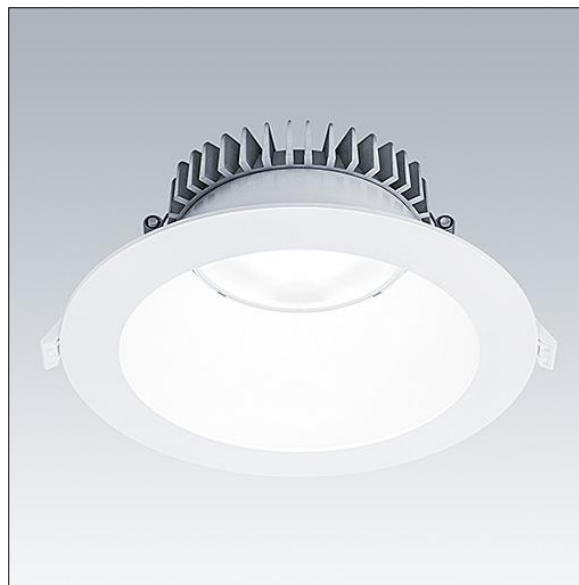

TLG_CTU3_F_L_LED_RWH_Persp.jpg

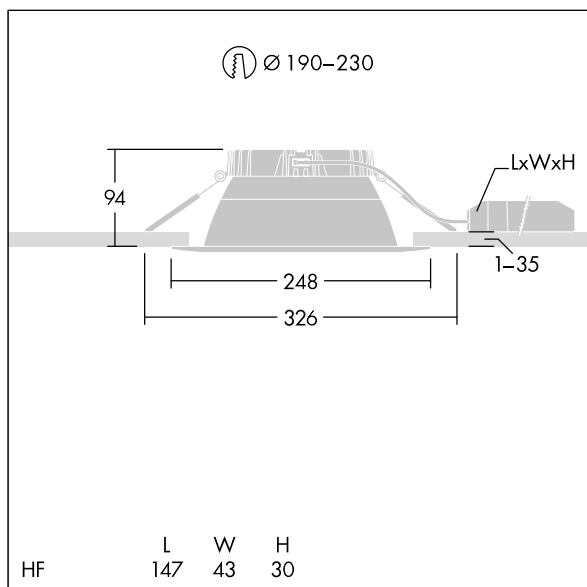

TLG_CTU3_M_HFL.wmf

This product contains a light source of energy efficiency class C.

All values marked with an * are rated values. Thorn uses tried and tested components from leading suppliers, however there may be isolated instances of technology-related failures of individual LEDs during the rated product lifetime. International standards set the tolerance in initial flux and connected load at ±10%. Unless stated otherwise, the values apply to an ambient temperature of 25°C.