

# Plurio

# THORN

92920896 PLI R 24L70-722-40 R/S T76 CL1 ANT



## Plurio

Plurio Indirect: A decorative post-top LED lantern with radially symmetric distribution. LED driver with 24 LEDs driven at 700mA. Class I electrical, IP66, IK08. Base: cast aluminium, powder coated anthracite (close to RAL7043). Canopy: round shape, aluminium, textured anthracite (close to RAL7043). Diffuser: UV stabilised, clear polycarbonate with anti-glare prisms. Indirect, reflector based optic. Complete with 2200-4000K NightTune LEDs. Post top mounting to Ø76mm column.

Upward lighting emissions below 1%.

Dimensions: Ø564 x 555 mm  
Luminaire input power: 51 W  
Luminaire luminous flux: 5386 lm  
Luminaire efficacy: 106 lm/W  
Weight: 9.11 kg  
Scx: 0.191 m<sup>2</sup>



TLG\_PLRL\_F\_IRC\_ANT.jpg

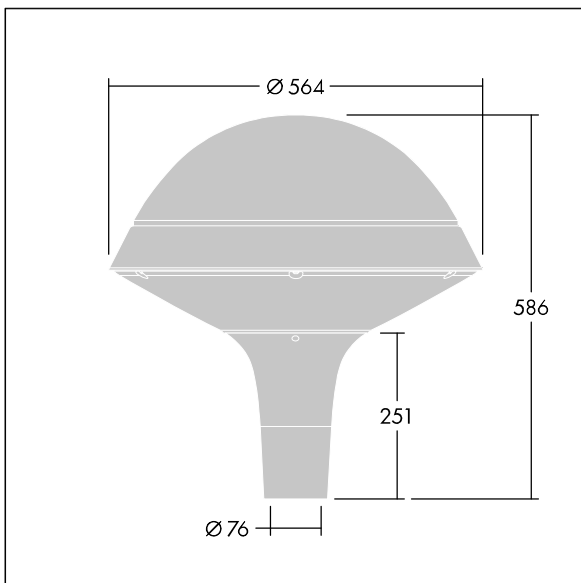

TLG\_PLRL\_M\_IRC\_T76.wmf

This product contains a light source of energy efficiency class D.

All values marked with an \* are rated values. Thorn uses tried and tested components from leading suppliers, however there may be isolated instances of technology-related failures of individual LEDs during the rated product lifetime. International standards set the tolerance in initial flux and connected load at ±10%. Unless stated otherwise, the values apply to an ambient temperature of 25°C.

Thorn Lighting is constantly developing and improving its products. The right is reserved to change specifications without prior notification or public announcement.  
© Thorn Lighting