

# Plurio

# THORN

92920864 PLI R 24L25-740 R/S BS 3550 T76 CL1 ANT



## Plurio

Plurio Indirect: A decorative post-top LED lantern with radially symmetric distribution. LED driver with 24 LEDs driven at 250mA. Class I electrical, IP66, IK08. Base: cast aluminium, powder coated anthracite (close to RAL7043). Canopy: round shape, aluminium, textured anthracite (close to RAL7043). Diffuser: UV stabilised, clear polycarbonate with anti-glare prisms. Indirect, reflector based optic. Equipped with 50% power reduction circuit, effective 3 hours before and 5 hours after a calculated midnight. It can be deactivated at installation with an easily accessible internal switch. Complete with 4000K LED. Post top mounting to Ø76mm column.

Upward lighting emissions below 1%.

Dimensions: Ø564 x 555 mm  
Luminaire input power: 19 W  
Luminaire luminous flux: 2416 lm  
Luminaire efficacy: 127 lm/W  
Weight: 8.76 kg  
Scx: 0.191 m<sup>2</sup>



TLG\_PLRL\_F\_IRC\_ANT.jpg

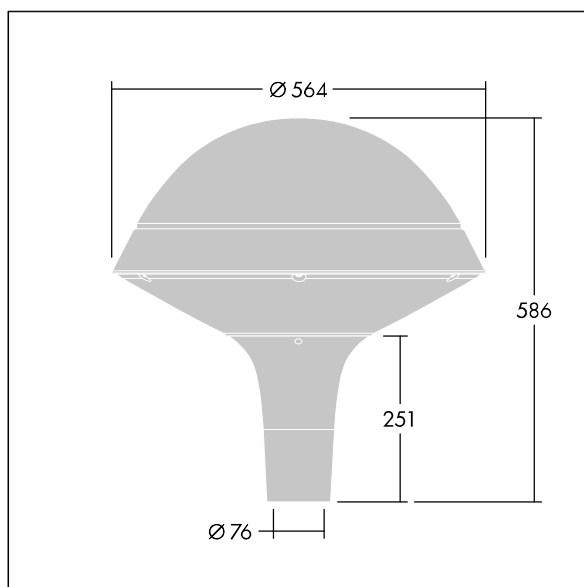

TLG\_PLRL\_M\_IRC\_T76.wmf

This product contains a light source of energy efficiency class D.

All values marked with an \* are rated values. Thorn uses tried and tested components from leading suppliers, however there may be isolated instances of technology-related failures of individual LEDs during the rated product lifetime. International standards set the tolerance in initial flux and connected load at ±10%. Unless stated otherwise, the values apply to an ambient temperature of 25°C.

Thorn Lighting is constantly developing and improving its products. The right is reserved to change specifications without prior notification or public announcement.  
© Thorn Lighting