

Steel Stepped Columns and Accessories

THORN

96632578 FLOOD BRAX1 0.5M FOR STEP COL 10M

Steel Stepped Columns and Accessories

Single 500mm floodlighting bracket for stirrup mounting a single floodlight

Weight: 7.17 kg (approx)

This bracket is suitable for use with the following columns:

96632561 : 10m stepped column, root mounted, Ø102mm top spigot

96632562 : 10m stepped column, flange mounted, Ø102mm top spigot

Please note : Delivery charges will apply to this item.

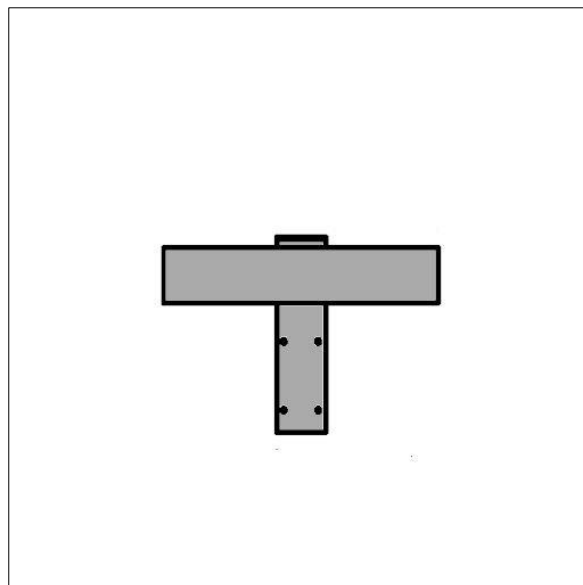

TLG_COLU_F_BRF15.jpg

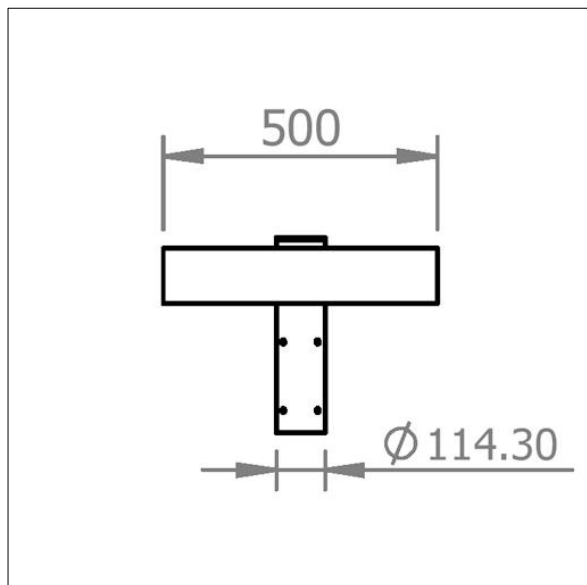

TLG_COLU_M_BRF110.wmf