

EP 445

96631771 EP445 36L70-730 CD-A BPS CL2 MSU



EP 445

A 19th Century style lantern with 36 LEDs with switchable drive current and Street & Comfort optic. Equipped with power reduction circuit, profile selected by rotary switch. Class II electrical (this product is not earthed), IP66, IK08. Body: die-cast aluminium, painted black (close to RAL9005) textured. Enclosure: 4mm thick extra clear glass. Complete with 3000K LED

Dimensions: 436 x 436 x 725 mm

Luminaire input power: 78 W

Weight: 8.7 kg

Scx: 0.19 m²



TLG_EP44_F_MSU.jpg

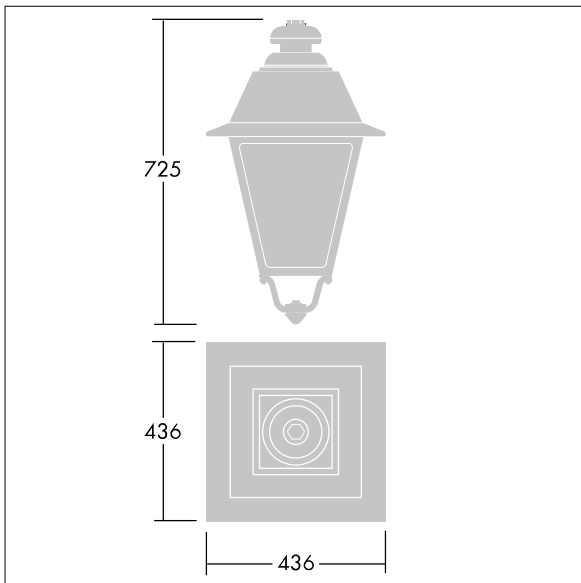

TLG_EP44_M_SUS.wmf

This product contains a light source of energy efficiency class D.