

# Glacier II

# THORN

96632409 GLAC2 L LED3 3500-830 HFIX EC BK GL PR



## Glacier II

A modern and efficient LED pendant luminaire. DALI dimmable control gear suitable for central battery emergency installations. Housing: die-cast aluminium with satin black finish. Reflector: prismatic glass with easy bayonet mount connection to housing. Class I electrical, IP20. Suspended via adjustable quick-lock 2.5m single wire suspension (supplied). Pre-wired with braided, flame retardant silicone cable, 5 x 0.75mm<sup>2</sup>. Complete with 3000K LED

Dimensions: Ø340/140 x 485 mm

Luminaire input power: 27 W

Weight: 6.8 kg



TLG\_GLCL\_F\_L\_BKGLPR.jpg

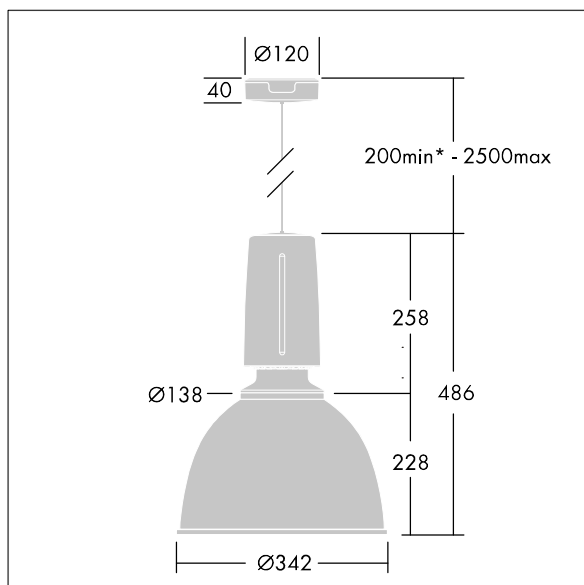

TLG\_GLCR\_M\_LED.wmf

This product contains a light source of energy efficiency class D.

All values marked with an \* are rated values. Thorn uses tried and tested components from leading suppliers, however there may be isolated instances of technology-related failures of individual LEDs during the rated product lifetime. International standards set the tolerance in initial flux and connected load at ±10%. Unless stated otherwise, the values apply to an ambient temperature of 25°C.

Thorn Lighting is constantly developing and improving its products. The right is reserved to change specifications without prior notification or public announcement.  
© Thorn Lighting