

# EP 445

96631759 EP445 36L70-730 ND-A BPS CL2 W5M MTP



## EP 445

A 19th Century style lantern with 36 LEDs with switchable drive current and Narrow Road optic. Post top mounting. Equipped with power reduction circuit, profile selected by rotary switch. Class II electrical (this product is not earthed), IP66, IK08. Body: die-cast aluminium, painted black (close to RAL9005) textured. Enclosure: 4mm thick extra clear glass. Pre-wired with 5m cable. Complete with 3000K LED

Dimensions: 436 x 436 x 695 mm

Luminaire input power: 78 W

Weight: 9.7 kg

Scx: 0.19 m<sup>2</sup>



TLG\_EP44\_F\_MTP.jpg

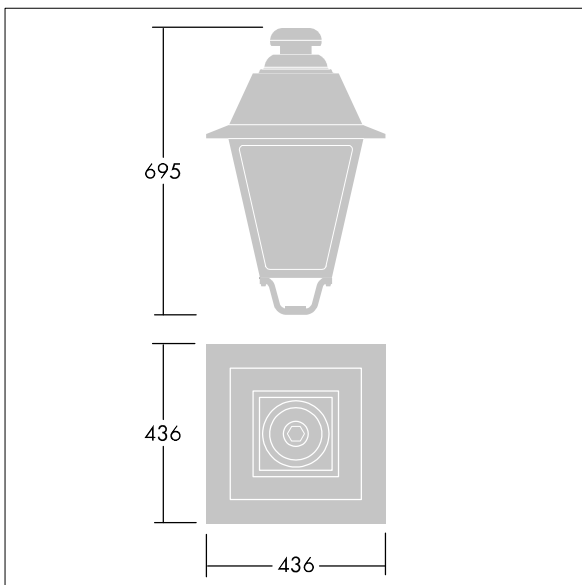

TLG\_EP44\_M\_MTP.wmf

This product contains a light source of energy efficiency class D.

**EP 445**

**96631759 EP445 36L70-730 ND-A BPS CL2 W5M MTP**

**THORN**