

THORN

Rivers

Distinctive appearance and striking performance



AMAZON
THAMES
SEINE
DANUBE
LOIRE



Rivers

Rivers is a unique collection of 5 contemporary luminaire ranges, including wall and ceiling mounted versions with each range designed to offer distinctive appearance and striking performance



The Rivers range satisfies the increasing demand for wall and ceiling luminaires that combine style with advanced and highly practical performance. This extensive collection caters for all solutions, providing choice and flexibility

- A range of unique diffusers in a variety of materials (glass, polycarbonate) and finishes (opal, prismatic)
- Striking bezel options – visor and grille
- A variety of colours (white, black, silver, satin chrome, anthracite) and round and square shapes
- Ideal for use in many applications including entrance halls, receptions, stairwells, corridors, circulation routes, rest areas, and building surrounds
- Large choice of lamp and gear variants

Rivers

The collection incorporates many features which simplify the installation process also making the product easily accessible for maintenance



1. The Quick Fix Wall and Ceiling Bracket (QFB), supplied with each product, simplifies installation to make it quick and easy, as the bracket can be pre-wired and mounted, without having to install the complete luminaire.
2. The unique 'light box' plug and play concept provides protection for the luminaire during the installation, ensures quick connection to the QFB and enables users to upgrade their installation.
3. The QFB has been designed with a locking device, to allow the light box to be easily removed from the QFB for safe maintenance (electrically disconnected).

A simple fastening mechanism allows easy access into the light box for maintenance.



1.



2.



3.



AMAZON
THAMES
SEINE
DANUBE
LOIRE

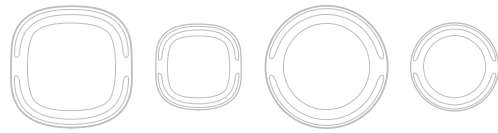

Amazon has a striking contemporary form, created by twin structural bridges between the elements of the cast aluminium bezel.

The diffuser is encircled and spills light onto the mounting surface in a directional halo.

Applications

Amazon is ideal to coordinate exterior (IP65) building surrounds with interior entrance halls or circulation areas.



- Aluminium base providing strength and rigidity
- A choice of two sizes in a circular or square design
- Striking opal polycarbonate diffuser
- Floating halo lighting effect
- Die-cast aluminium bezel available in white, silver or anthracite, to suit application
- Integral 3 hour maintained emergency versions, suitable for escape routes
- Large choice of compact fluorescent and T5 (T16-R) circular lamps
- Available with Electronic and Electronic Digital Dimming ballast
- Quick Fix Bracket supplied for safe and quick installation
- IP65 for exterior applications

Lamps

- ☰ 18W, TC-DEL (FSD) compact fluorescent. Cap: G24q-2
- ☷ 26W, TC-DEL (FSQ) compact fluorescent. Cap: G24q-3
- Ⓜ 16, 28, 38W, TC-DDEL (FSS) compact fluorescent. Cap: GR10q
- ⊙ 40, 55W, T16-R (FSC) circular fluorescent. Cap: 2GX13

Materials/Finish

Body: die-cast aluminium
 Bezel: die-cast aluminium, silver, anthracite, and white finish
 Diffuser: opal polycarbonate.

Installation/Mounting

Suitable for surface mounting on wall or ceiling for both interior and exterior use. 'Quick Fix Bracket' (QFB) screw fixed onto mounting surface by 4 slotted holes (4.5mm x 10mm). Main connection via 6 way connecting block. 'Light Box' direct and auto-connected to the QFB. For loop wiring use double 20mm cable entry holes to rear of QFB.

Standards

Designed and manufactured to comply with EN60598, EN55015: 2000 (EMC). Emergency versions with EN60598-2.22.
 Ⓛ Class1 Electrical
 ⚡ IP65 Ⓢ CE

Specification

To specify state:
 Striking circular/square luminaire for 18, 26W TC-DEL /16, 28, 38W TC-DDEL compact fluorescent / 40, 55W T16-R circular fluorescent lamp(s) with die-cast aluminium 'floating halo' and double ring mounting and twin bridge with opal polycarbonate diffuser mounted to a die-cast aluminium body, with lamp and electronic/electronic dimmable/integral emergency gear, connected to Quick Fix Wall and Ceiling Bracket. As Thorn Amazon.



Silver



Anthracite

AMAZON
THAMES
SEINE
DANUBE
LOIRE



Thames has a concave diffuser face and tapered sides, which create a unique and distinctive appearance. Backlighting generates a floating halo effect.

Applications

Thames adds style and variety to an installation. Two sizes are offered in circular or square shaped designs, all complemented by a choice of high quality finishes. Sealed to IP44, Thames is eminently suitable for certain exterior uses.

The floating halo light effect reduces light contrast between the luminaire and the mounting surface to improve lighting comfort.



- Aluminium body providing strength and rigidity
- A choice of two sizes in a circular or square design
- Characteristic concave opal polycarbonate diffuser
- Floating halo lighting effect
- Metallic bezel available in white, silver or satin chrome, to suit application
- Integral 3 hour maintained emergency versions, suitable for escape routes
- Large choice of compact fluorescent and T5 (T16-R) circular lamps
- Available with Electronic and Electronic Digital Dimming ballast
- Quick Fix Bracket supplied for safe and quick installation
- Sealed to IP44

Lamps

- ☰ 18W, TC-DEL (FSD) compact fluorescent. Cap: G24q-2
- ☷ 26W, TC-DEL (FSQ) compact fluorescent. Cap: G24q-3
- ⊕ 16, 28, 38W, TC-DDEL (FSS) compact fluorescent. Cap: GR10q
- 40, 55W, T16-R (FSC) circular fluorescent. Cap: 2GX13

Materials/Finish

- Body: die-cast aluminium
- Bezel: steel, silver, satin chrome and white finish
- Diffuser: opal polycarbonate

Installation/Mounting

Suitable for surface mounting on wall or ceiling for both interior or exterior use. 'Quick Fix Bracket' (QFB) screw fixed onto mounting surface by 4 slotted holes (4.5mm x 10mm). Main connection via 6 way connecting block. 'Light Box' direct and auto-connected to the QFB. For loop wiring use double 20mm cable entry holes to rear of QFB.

Standards

- Designed and manufactured to comply with EN60598, EN55015: 2000 (EMC). Emergency versions with EN60598 (2.22).
- ⚡ Class 1 Electrical
- ⚠ IP44 

Specification

To Specify state: Unique and distinctive circular /square luminaire for 18, 26W TC-DEL /16, 28, 38W TC-DDEL compact fluorescent / 40, 55W T16-R circular fluorescent with an acute angular steel bezel 'floating halo' with concave opal polycarbonate diffuser mounted on a die-cast aluminium body, with lamp and electronic/electronic dimmable/integral emergency gear, connected to Quick Fix Wall and Ceiling Bracket. As Thorn Thames.



White



Satin Chrome



AMAZON
THAMES
SEINE
DANUBE
LOIRE



Seine has clean edges combined with a smooth fronted diffuser, designed in glass for a classical appearance, with a contemporary feel.

Applications

The unique 'cushion' design diffuses an evenly distributed comfortable lighting effect and has a modern appearance when unlit for executive offices, corridors and meeting rooms, also hotel receptions and circulation areas.



- Aluminium body providing strength and rigidity
- A choice of two sizes in a circular or square design
- Distinctive 'cushion' shape opal glass diffuser providing smooth diffused light
- Aesthetic appeal both lit and unlit
- Unique floating halo lighting effect
- Integral 3 hour maintained emergency versions, suitable for escape routes
- Large choice of compact fluorescent and T5 (T16-R) circular lamps
- Available with Electronic and Electronic Digital Dimming ballast
- Quick Fix Bracket supplied for safe and quick installation

Lamps

- ☰ 18W, TC-DEL (FSD) compact fluorescent. Cap: G24q-2
- ☷ 26W, TC-DEL (FSQ) compact fluorescent. Cap: G24q-3
- Ⓜ 16, 28, 38W, TC-DDEL (FSS) compact fluorescent. Cap: GR10q
- 40, 55W, T16-R (FSC) circular fluorescent. Cap: 2GX13

Materials/Finish

Body: die-cast aluminium with polycarbonate fixation
Diffuser: opal glass.

Installation/Mounting

Suitable for surface mounting on wall or ceiling for interior use. 'Quick Fix Bracket' (QFB) screw fixed onto mounting surface by 4 slotted holes (4.5mm x 10mm). Main connection via 6 way connecting block. 'Light Box' direct and auto-connected to the QFB. For loop wiring use double 20mm cable entry holes to rear of QFB.

Standards

Designed and manufactured to comply with EN60598, EN55015: 2000 (EMC). Emergency versions with EN60598-2.22.
Ⓢ Class1 Electrical. IP20 

Specification

To specify state:
Classic circular/square luminaire for 18, 26W TC-DEL / 16, 28, 38W TC-DDEL compact fluorescent / 40, 55W T16-R circular fluorescent lamps with 'Floating curved cushion' backlighting 'halo', opal glass diffuser with lamp and electronic/ electronic dimmable/ integral emergency gear, connected to Quick Fix Wall and Ceiling Bracket. As Thorn Seine.



AMAZON
THAMES
SEINE
DANUBE
LOIRE

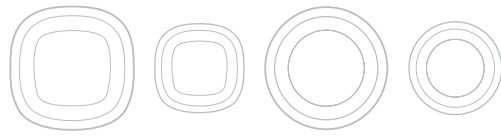

Danube utilises a flat front diffuser and bold flared sides to create a low profile luminaire. Versions fitted with visor or grille bezels can alter the character to suit a wide range of environments.

Applications

Danube covers a wide range of interior or exterior applications using the same product family differentiated by the shape (round or square), the bezel or the colour.



- A choice of two sizes in a circular or square design
- Flat fronted opal or clear prismatic polycarbonate diffuser
- Available in black or white to suit application
- Grille and visor versions available for aesthetic appearance
- Integral 3 hour maintained emergency versions, suitable for escape routes
- Large choice of compact fluorescent and T5 (T16-R) circular lamps
- Available with Electronic or Electronic Digital Dimming ballast
- IP65 for exterior installations
- Quick Fix Bracket supplied for safe and quick installation

Lamps

- ☰ 18W, TC-DEL (FSD) compact fluorescent. Cap: G24q-2
- ☷ 26W, TC-DEL (FSQ) compact fluorescent. Cap: G24q-3
- Ⓜ 16, 28, 38W, TC-DDEL (FSS) compact fluorescent. Cap: GR10q
- 40W, T16-R (FSC) circular fluorescent. Cap: 2GX13

Materials/Finish

Body: polycarbonate
 Diffuser: opal polycarbonate or clear prismatic polycarbonate
 Bezel, visor and grille: polycarbonate, white or black finish

Installation/Mounting

Suitable for surface mounting on wall or ceiling for both interior and exterior use. 'Quick Fix Bracket' (QFB) screw fixed onto mounting surface by 4 slotted holes (4.5mm x 10mm). Main connection via 6 way connecting block. 'Light Box' direct and auto-connected to the QFB. For loop wiring use double 20mm cable entry holes to rear of QFB.

Standards

Designed and manufactured to comply with EN60598, EN55015: 2000 (EMC). Emergency versions with EN60598-2.22.
 Ⓢ Class I Electrical
 ⚡ IP65 Ⓢ CE

Specification

To specify state:
 Bold and versatile circular/square luminaire for 18, 26W TC-DEL / 16, 28, 38W TC-DDEL compact fluorescent / 40W T16-R circular fluorescent lamps with polycarbonate body, 'flat' opal and prismatic diffuser with standard/grille/visor bezel in colour with lamp, electronic/ electronic dimmable/integral emergency gear, connected to Quick Fix Wall and Ceiling Bracket. As Thorn Danube.

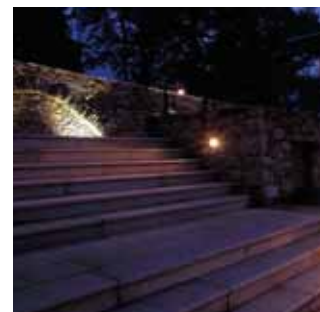

AMAZON
THAMES
SEINE
DANUBE
LOIRE



Loire has a fresh design with a contemporary feel, the diffusers are in glass or polycarbonate. Versions fitted with a grille or visor are available.

Applications

A secure fitting using tamper resistant screws for public interior and exterior (IP65 version) circulation areas including stairwells, corridors and store rooms.



- Available in two sizes in a circular design
- Opal polycarbonate or glass diffuser
- Available in black or white
- Grille and visor versions available
- Integral 3 hour maintained emergency versions, suitable for escape routes
- Large choice of low energy compact fluorescent lamps
- Available with Electronic ballast (Digital dimming versions available to order)
- IP65 polycarbonate versions for exterior installations
- Tamper proof diffuser retaining screw device to protect installation
- Quick Fix Bracket supplied for safe and quick installation

Lamps

☰ 18W, TC-DEL (FSD) compact fluorescent.
Cap: G24q-2
☰ 16, 28, 38W, TC-DDEL (FSS) compact fluorescent.
Cap: GR10q

Materials/Finish

Body: polycarbonate
Bezel, grille and visor: polycarbonate, white or black finish
Diffuser: opal polycarbonate or glass

Installation/Mounting

Suitable for surface mounting on wall or ceiling for both interior or exterior use.
'Quick Fix Bracket' (QFB) screw fixed onto mounting surface by 4 slotted holes (4.5mm x 10mm). Main connection via 6 way connecting block. 'Light Box' direct and auto-connected to the QFB. For loop wiring use double 20mm cable entry holes to rear of QFB.

Standards

Designed and manufactured to comply with EN60598, EN55015: 2000 (EMC).
Emergency versions with EN60598-2.22.

⊕ Class I Electrical

⚡ IP65

(polycarbonate diffuser)

IP20 (glass diffuser)

CE

Specification

To specify state:
Fresh and contemporary circular luminaire for 18W TC-DEL /16, 28, 38W TC-DDEL compact fluorescent lamp(s) with polycarbonate body and opal diffuser in glass/polycarbonate with standard/grille/visor bezels in colour with lamp, electronic/integral emergency gear, connected to Quick Fix Wall and Ceiling Bracket.
As Thorn Loire.





Dimensions

Photometric data

Ordering guide

Amazon

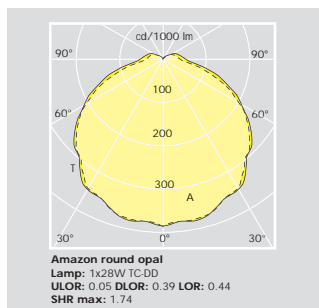

Round, white

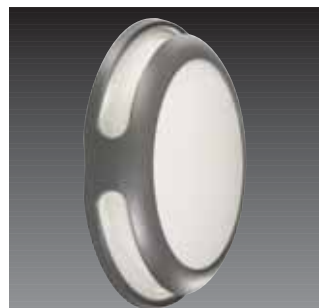

Round, anthracite



Square, silver

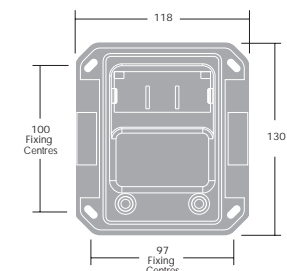
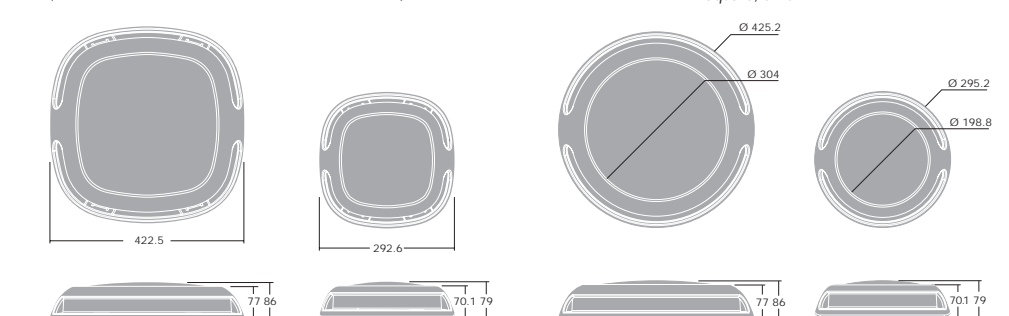
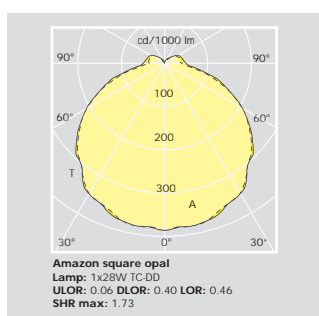

Quick Fix Bracket

Ordering Guide Supplied complete with Quick Fix Bracket and lamp(s) 4000K

Description	Iicos Code	Socket	Weight (Kg)	Cat.No.		
				White	Silver	Anthracite
Round small						
AM 1X16W TC-DDEL HF RD S	FSS	GR10q	1.5	AMROZ2D16W	AMROZ2D16S	AMROZ2D16A
Square small						
AM 1X16W TC-DDEL HF SQ S	FSS	GR10q	1.55	AMSOZ2D16W	AMSOZ2D16S	AMSOZ2D16A
Round large						
AM 2X18W TC-DEL HF RD L	FSD	G24q-2	2.85	AMROZ218W	AMROZ218S	AMROZ218A
AM 2X18W TC-DEL HFD RD L	FSD	G24q-2	2.85	AMROCLD218W	AMROCLD218S	AMROCLD218A
AM 2X26W TC-DEL HF RD L	FSD	G24q-3	2.9	AMROZ226W	AMROZ226S	AMROZ226A
AM 2X26W TC-DEL HFD RD L	FSD	G24q-3	2.9	AMROCLD226W	AMROCLD226S	AMROCLD226A
AM 1X28W TC-DDEL HF RD L	FSS	GR10q	2.65	AMROZ2D28W	AMROZ2D28S	AMROZ2D28A
AM 1X38W TC-DDEL HF RD L	FSS	GR10q	2.8	AMROZ2D38W	AMROZ2D38S	AMROZ2D38A
AM 1X40W T16-R HF RD L	FSC	2GX13	2.4	AMROT5C40W	AMROT5C40S	AMROT5C40A
AM 1X40W T16-R HFD RD L	FSC	2GX13	2.4	AMROCLDT5C40W	AMROCLDT5C40S	AMROCLDT5C40A
AM 1X55W T16-R HF RD L	FSC	2GX13	2.4	AMROT5C55W	AMROT5C55S	AMROT5C55A
AM 1X55W T16-R HFD RD L	FSC	2GX13	2.4	AMROCLDT5C55W	AMROCLDT5C55S	AMROCLDT5C55A
Round large - emergency versions						
AM 2X18W TC-DEL HF E3 RD L	FSD	G24q-2	3.5	E3AMROZ218W	E3AMROZ218S	E3AMROZ218A
AM 1X28W TC-DDEL HF E3 RD L	FSS	GR10q	3.4	E3AMROZ2D28W	E3AMROZ2D28S	E3AMROZ2D28A
AM 1X38W TC-DDEL HF E3 RD L	FSS	GR10q	3.6	E3AMROZ2D38W	E3AMROZ2D38S	E3AMROZ2D38A
Square large						
AM 2X18W TC-DEL HF SQ L	FSD	G24q-2	3	AMSOZ218W	AMSOZ218S	AMSOZ218A
AM 2X18W TC-DEL HFD SQ L	FSD	G24q-2	3	AMSOCLD218W	AMSOCLD218S	AMSOCLD218A
AM 2X26W TC-DEL HF SQ L	FSD	G24q-3	3.05	AMSOZ226W	AMSOZ226S	AMSOZ226A
AM 2X26W TC-DEL HFD SQ L	FSD	G24q-3	3.05	AMSOCLD226W	AMSOCLD226S	AMSOCLD226A
AM 1X28W TC-DDEL HF SQ L	FSS	GR10q	2.8	AMSOZ2D28W	AMSOZ2D28S	AMSOZ2D28A
AM 1X38W TC-DDEL HF SQ L	FSS	GR10q	2.95	AMSOZ2D38W	AMSOZ2D38S	AMSOZ2D38A
Square large - emergency versions						
AM 2X18W TC-DEL HF SQ L	FSD	G24q-2	3.5	E3AMSOZ218W	E3AMSOZ218S	E3AMSOZ218A
AM 1X28W TC-DDEL HF E3 SQ L	FSS	GR10q	3.6	E3AMSOZ2D28W	E3AMSOZ2D28S	E3AMSOZ2D28A
AM 1X38W TC-DDEL HF E3 SQ L	FSS	GR10q	3.7	E3AMSOZ2D38W	E3AMSOZ2D38S	E3AMSOZ2D38A

HF - High Frequency, HFD - High Frequency Digital Dimmable

Dimensions

Photometric data

Ordering guide

Thames

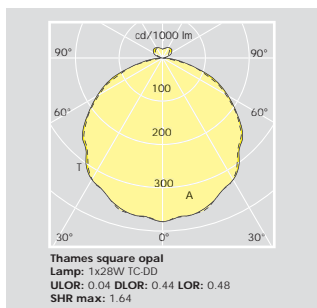

Square, white



Round, satin chrome



Round, white

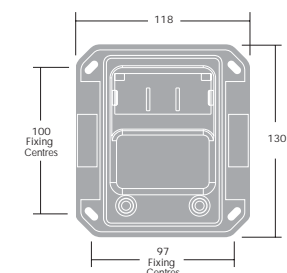
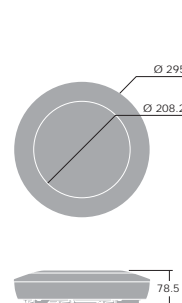
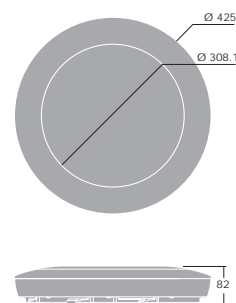
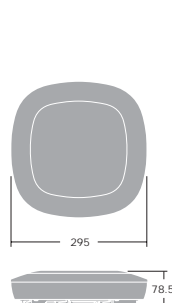
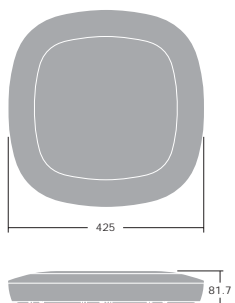
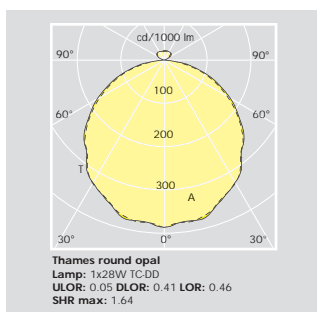

Quick Fix Bracket

Ordering Guide Supplied complete with Quick Fix Bracket and lamp(s) 4000K

Description	Icos Code	Socket	Weight (Kg)	Cat.No.		
				White	Silver	Satin Chrome
Round small						
TH 1X16W TC-DDEL HF RD S	FSS	GR10q	1.70	THROZ2D16W	THROZ2D16S	THROZ2D16C
Square small						
TH 1X16W TC-DDEL HF SQ S	FSS	GR10q	1.75	THSOZ2D16W	THSOZ2D16S	THSOZ2D16C
Round large						
TH 2X18W TC-DEL HF RD L	FSD	G24q-2	3.15	THROZ218W	THROZ218S	THROZ218C
TH 2X18W TC-DEL HFD RD L	FSD	G24q-2	3.15	THROCLD218W	THROCLD218S	THROCLD218C
TH 2X26W TC-DEL HF RD L	FSQ	G24q-3	3.2	THROZ226W	THROZ226S	THROZ226C
TH 2X26W TC-DEL HFD RD L	FSQ	G24q-3	3.2	THROCLD226W	THROCLD226S	THROCLD226C
TH 1X28W TC-DDEL HF RD L	FSS	GR10q	2.9	THROZ2D28W	THROZ2D28S	THROZ2D28C
TH 1X38W TC-DDEL HF RD L	FSS	GR10q	3.05	THROZ2D38W	THROZ2D38S	THROZ2D38C
TH 1X40W T16-R HF RD L	FSC	2GX13	2.7	THROT5C40W	THROT5C40S	THROT5C40C
TH 1X40W T16-R HFD RD L	FSC	2GX13	2.7	THROCLDT5C40W	THROCLDT5C40S	THROCLDT5C40C
TH 1X55W T16-R HF RD L	FSC	2GX13	2.7	THROT5C55W	THROT5C55S	THROT5C55C
TH 1X55W T16-R HFD RD L	FSC	2GX13	2.7	THROCLDT5C55W	THROCLDT5C55S	THROCLDT5C55C
Round large - emergency versions						
TH 2X18W TC-DEL HF E3 RD L	FSD	G24q-2	3.7	E3THROZ218W	E3THROZ218S	E3THROZ218C
TH 1X28W TC-DDEL HF E3 RD L	FSS	GR10q	3.7	E3THROZ2D28W	E3THROZ2D28S	E3THROZ2D28C
TH 1X38W TC-DDEL HF E3 RD L	FSS	GR10q	3.7	E3THROZ2D38W	E3THROZ2D38S	E3THROZ2D38C
Square large						
TH 2X18W TC-DEL HF SQ L	FSD	G24q-2	3.35	THSOZ218W	THSOZ218S	THSOZ218C
TH 2X18W TC-DEL HFD SQ L	FSD	G24q-2	3.35	THSOCLD218W	THSOCLD218S	THSOCLD218C
TH 2X26W TC-DEL HF SQ L	FSQ	G24q-3	3.4	THSOZ226W	THSOZ226S	THSOZ226C
TH 2X26W TC-DEL HFD SQ L	FSQ	G24q-3	3.4	THSOCLD226W	THSOCLD226S	THSOCLD226C
TH 1X28W TC-DDEL HF SQ L	FSS	GR10q	3.1	THSOZ2D28W	THSOZ2D28S	THSOZ2D28C
TH 1X38W TC-DDEL HF SQ L	FSS	GR10q	3.3	THSOZ2D38W	THSOZ2D38S	THSOZ2D38C
Square large - emergency versions						
TH 2X18W TC-DEL HF E3 SQ L	FSD	G24q-2	4.0	E3THSOZ218W	E3THSOZ218S	E3THSOZ218C
TH 1X28W TC-DDEL HF E3 SQ L	FSS	GR10q	4.0	E3THSOZ2D28W	E3THSOZ2D28S	E3THSOZ2D28C
TH 1X38W TC-DDEL HF E3 SQ L	FSS	GR10q	4.0	E3THSOZ2D38W	E3THSOZ2D38S	E3THSOZ2D38C

HF - High Frequency, HFD - High Frequency Dimmable Digital

Seine

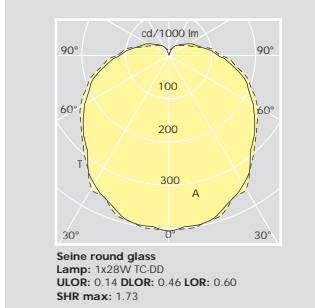

Large, round



Large, square

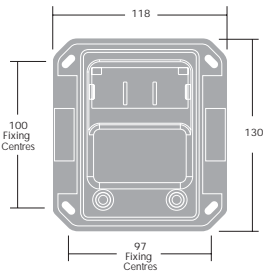
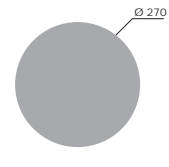
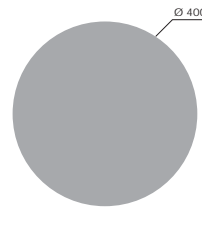
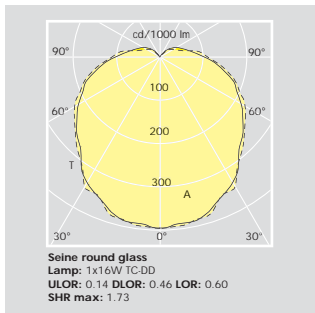

Quick Fix Bracket

Ordering Guide Supplied complete with Quick Fix Bracket and lamp(s) 4000K

Description	Ilcos Code	Socket	Weight (Kg)	Cat.No.
Round small				
SE 1X16W TC-DDEL HF RD S	FSS	GR10q	2.9	SEROZ2D16
Square small				
SE 1X16W TC-DDEL HF SQ S	FSS	GR10q	2.9	SESOZ2D16
Round large				
SE 2X18W TC-DEL HF RD L	FSD	G24q-2	4.6	SEROZ218
SE 2X18W TC-DEL HFD RD L	FSD	G24q-2	4.6	SEROCLD218
SE 2X26W TC-DEL HF RD L	FSQ	G24q-3	4.85	SEROZ226
SE 2X26W TC-DEL HFD RD L	FSQ	G24q-3	4.85	SEROCLD226
SE 1X28W TC-DDEL HF RD L	FSS	GR10q	4.6	SEROZ2D28
SE 1X38W TC-DDEL HF RD L	FSS	GR10q	4.75	SEROZ2D38
SE 1X40W T16-R HF RD L	FSC	2GX13	4.5	SEROT5C40
SE 1X40W T16-R HFD RD L	FSC	2GX13	4.5	SEROCLD15C40
SE 1X55W T16-R HF RD L	FSC	2GX13	4.5	SEROT5C55
SE 1X55W T16-R HFD RD L	FSC	2GX13	4.5	SEROCLD15C55
Round large - emergency versions				
SE 2X18W TC-DEL HF E3 RD L	FSD	G24q-2	5.4	E3SEROZ218
SE 1X28W TC-DDEL HF E3 RD L	FSS	GR10q	5.4	E3SEROZ2D28
SE 1X38W TC-DDEL HF E3 RD L	FSS	GR10q	5.4	E3SEROZ2D38
Square large				
SE 2X18W TC-DEL HF SQ L	FSD	G24q-2	5.05	SESOZ218
SE 2X18W TC-DEL HFD SQ L	FSD	G24q-2	5.05	SESOCLD218
SE 2X26W TC-DEL HF SQ L	FSQ	G24q-3	5.05	SESOZ226
SE 2X26W TC-DEL HFD SQ L	FSQ	G24q-3	5.05	SESOCLD226
SE 1X28W TC-DDEL HF SQ L	FSS	GR10q	4.8	SESOZ2D28
SE 1X38W TC-DDEL HF SQ L	FSS	GR10q	4.95	SESOZ2D38
Square large - emergency versions				
SE 2X18W TC-DEL HF E3 SQ L	FSD	G24q-2	5.6	E3SESOZ218
SE 1X28W TC-DDEL HF E3 SQ L	FSS	GR10q	5.6	E3SESOZ2D28
SE 1X38W TC-DDEL HF E3 SQ L	FSS	GR10q	5.6	E3SESOZ2D38

HF - High Frequency, HFD - High Frequency Digital Dimmable

Dimensions

Photometric data

Ordering guide

Danube



Round, white



Round with visor, black



Round prismatic, black

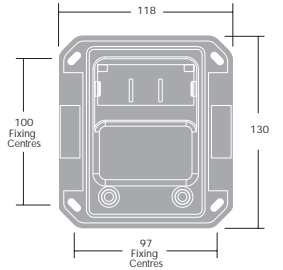

Quick Fix Bracket

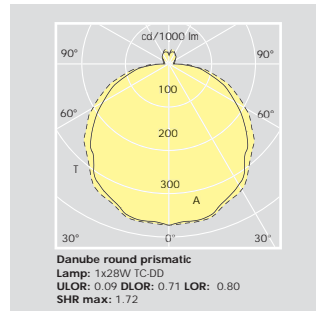
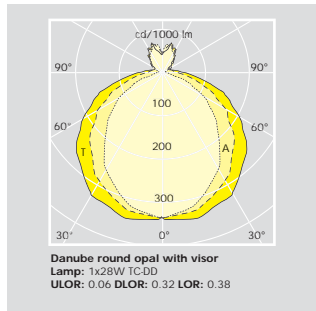
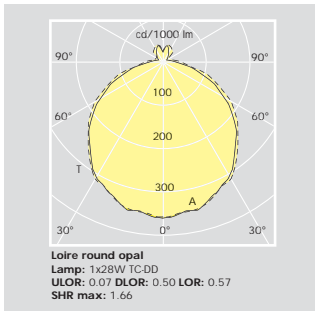

Ordering Guide Supplied complete with Quick Fix Bracket and lamp(s) 4000K

Description	Ilcos Code	Socket	Wt (Kg)	Cat.No.	
				Black	White
Opal diffuser – round small					
DA 1X16W TC-DDEL HF CL1 OP RD S	FSS	GR10q	0.95	DAROVZ2D16B	DAROVZ2D16W
Opal diffuser with visor – round small					
DA VIS 1X16W TC-DDEL HF CL1 OP RD S	FSS	GR10q	1.05	DAROVZ2D16B	DAROVZ2D16W
Opal diffuser with grille – round small					
DA GRIL 1X16W TC-DDEL HF CL1 OP RD S	FSS	GR10q	1.05	DAROVZ2D16B	DAROVZ2D16W
Prismatic diffuser – round small					
DA 1X16W TC-DDEL HF CL1 PR SQ S	FSS	GR10q	0.95	DAROVZ2D16B	DAROVZ2D16W
Opal diffuser – square small					
DA 1X16W TC-DDEL HF CL1 OP SQ S	FSS	GR10q	0.95	DASOVZ2D16B	DASOVZ2D16W
Opal diffuser with visor – square small					
DA VIS 1X16W TC-DDEL HF CL1 OP SQ S	FSS	GR10q	1.05	DASOVZ2D16B	DASOVZ2D16W
Opal diffuser with grille – square small					
DA GRIL 1X16W TC-DDEL HF CL1 OP SQ S	FSS	GR10q	1.05	DASOVZ2D16B	DASOVZ2D16W

Description	Ilcos Code	Socket	Wt (Kg)	Cat.No.	
				Black	White
Prismatic diffuser – square small					
DA 1X16W TC-DDEL HF CL1 PR SQ S	FSS	GR10q	0.95	DASPZ2D16B	DASPZ2D16W
Opal diffuser – round large					
DA 2X18W TC-DEL HF CL1 OP RD L	FSD	G24q-2	2.1	DAROVZ218B	DAROVZ218W
DA 2X18W TC-DEL HFD CL1 OP RD L	FSD	G24q-2	2.1	DAROVZ218B	DAROVZ218W
DA 2X26W TC-DEL HF CL1 OP RD L	FSQ	G24q-3	1.9	DAROVZ226B	DAROVZ226W
DA 2X26W TC-DEL HFD CL1 OP RD L	FSQ	G24q-3	1.9	DAROVZ226B	DAROVZ226W
DA 1X28W TC-DDEL HF CL1 OP RD L	FSS	GR10q	1.65	DAROVZ2D28B	DAROVZ2D28W
DA 1X38W TC-DDEL HF CL1 OP RD L	FSS	GR10q	1.8	DAROVZ2D38B	DAROVZ2D38W
DA 1X40W T16-R HF CL1 OP RD L	FSC	2GX13	1.65	DAROVZ5C40B	DAROVZ5C40W
Opal diffuser – round large – emergency versions					
DA 1X28W TC-DDEL HF CL1 E3 OP RD L	FSS	GR10q	2.5	E3DAROVZ2D28B	E3DAROVZ2D28W
DA 1X38W TC-DDEL HF CL1 E3 OP RD L	FSS	GR10q	2.5	E3DAROVZ2D38B	E3DAROVZ2D38W
Opal diffuser with visor – round large					
DA VIS 2X18W TC-DEL HF CL1 OP RD L	FSD	G24q-2	2.25	DAROVZ218B	DAROVZ218W
DA VIS 2X18W TC-DEL HFD CL1 OP RD L	FSD	G24q-2	2.25	DAROVZ218B	DAROVZ218W
DA VIS 2X26W TC-DEL HF CL1 OP RD L	FSQ	G24q-3	2.05	DAROVZ226B	DAROVZ226W
DA VIS 2X26W TC-DEL HFD CL1 OP RD L	FSQ	G24q-3	2.05	DAROVZ226B	DAROVZ226W
DA VIS 1X28W TC-DDEL HF CL1 OP RD L	FSS	GR10q	1.8	DAROVZ2D28B	DAROVZ2D28W
DA VIS 1X38W TC-DDEL HF CL1 OP RD L	FSS	GR10q	1.95	DAROVZ2D38B	DAROVZ2D38W
DA VIS 1X40W T16-R HF CL1 OP RD L	FSC	2GX13	1.8	DAROVZ5C40B	DAROVZ5C40W
Opal diffuser with visor – round large – emergency versions					
DA VIS 1X28W TC-DDEL HF CL1 E3 OP RD L	FSS	GR10q	2.65	E3DAROVZ2D28B	E3DAROVZ2D28W
DA VIS 1X38W TC-DDEL HF CL1 E3 OP RD L	FSS	GR10q	2.65	E3DAROVZ2D38B	E3DAROVZ2D38W

Danube

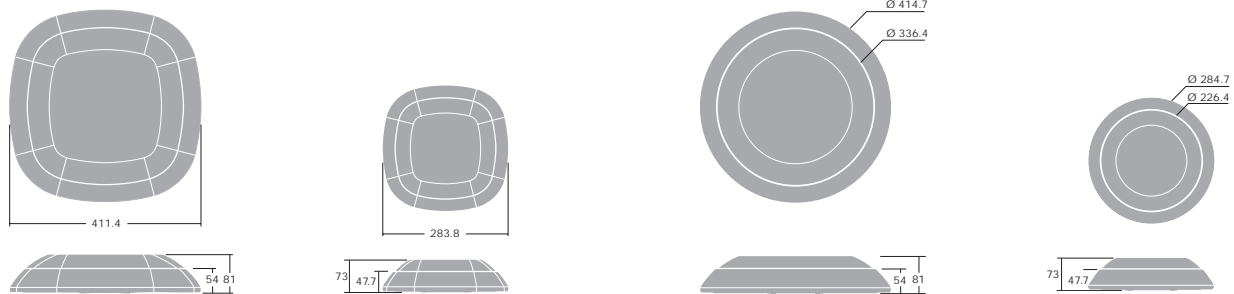

Ordering Guide Supplied complete with Quick Fix Bracket and lamp(s) 4000K

Description	Icos Code	Socket	Wt (Kg)	Cat.No. Black	White
Opal diffuser with grille - round large					
DA GRIL 2X18W TC-DEL HF CL1 OP RD L	FSD	G24q-2	2.25	DAROGZ218B	DAROGZ218W
DA GRIL 2X18W TC-DEL HFD CL1 OP RD L	FSD	G24q-2	2.25	DAROGCLD218B	DAROGCLD218W
DA GRIL 2X26W TC-DEL HF CL1 OP RD L	FSQ	G24q-3	2.05	DAROGZ226B	DAROGZ226W
DA GRIL 2X26W TC-DEL HFD CL1 OP RD L	FSQ	G24q-3	2.05	DAROGCLD226B	DAROGCLD226W
DA GRIL 1X28W TC-DDEL HF CL1 OP RD L	FSS	GR10q	1.8	DAROGZ2D28B	DAROGZ2D28W
DA GRIL 1X38W TC-DDEL HF CL1 OP RD L	FSS	GR10q	1.95	DAROGZ2D38B	DAROGZ2D38W
DA GRIL 1X40W T16-R HF CL1 OP RD L	FSC	2GX13	1.8	DAROGT5C40B	DAROGT5C40W
Opal diffuser with grille - round large - emergency versions					
DA GRIL 1X28W TC-DDEL HF CL1 E3 OP RD L	FSS	GR10q	2.65	E3DAROGZ2D28B	E3DAROGZ2D28W
DA GRIL 1X38W TC-DDEL HF CL1 E3 OP RD L	FSS	GR10q	2.65	E3DAROGZ2D38B	E3DAROGZ2D38W
Prismatic diffuser - round large					
DA 2X18W TC-DEL HF CL1 PR RD L	FSD	G24q-2	2.1	DARPZ218B	DARPZ218W
DA 2X18W TC-DEL HFD CL1 PR RD L	FSD	G24q-2	2.1	DARPCLD218B	DARPCLD218W
DA 2X26W TC-DEL HF CL1 PR RD L	FSQ	G24q-3	1.9	DARPZ226B	DARPZ226W
DA 2X26W TC-DEL HFD CL1 PR RD L	FSQ	G24q-3	2.05	DARPCLD226B	DARPCLD226W
DA 1X28W TC-DDEL HF CL1 PR RD L	FSS	GR10q	1.65	DARPZ2D28B	DARPZ2D28W
DA 1X38W TC-DDEL HF CL1 PR RD L	FSS	GR10q	1.8	DARPZ2D38B	DARPZ2D38W
DA 1X40W T16-R HF CL1 PR RD L	FSC	2GX13	1.65	DARPT5C40B	DARPT5C40W
Prismatic diffuser - round large - emergency versions					
DA 1X28W TC-DDEL HF CL1 E3 PR RD L	FSS	GR10q	2.5	E3DARPZ2D28B	E3DARPZ2D28W
DA 1X38W TC-DDEL HF CL1 E3 PR RD L	FSS	GR10q	2.5	E3DARPZ2D38B	E3DARPZ2D38W
Opal diffuser - square large					
DA 2X18W TC-DEL HF CL1 OP SQ L	FSD	G24q-2	1.95	DASOZ218B	DASOZ218W
DA 2X18W TC-DEL HFD CL1 OP SQ L	FSD	G24q-2	1.95	DASOCLD218B	DASOCLD218W
DA 2X26W TC-DEL HF CL1 OP SQ L	FSQ	G24q-3	1.95	DASOZ226B	DASOZ226W
DA 2X26W TC-DEL HFD CL1 OP SQ L	FSQ	G24q-3	1.95	DASOCLD226B	DASOCLD226W
DA 1X28W TC-DDEL HF CL1 OP SQ L	FSS	GR10q	1.7	DASOZ2D28B	DASOZ2D28W
DA 1X38W TC-DDEL HF CL1 OP SQ L	FSS	GR10q	1.85	DASOZ2D38B	DASOZ2D38W
Opal diffuser - square large - emergency versions					
DA 1X28W TC-DDEL HF CL1 E3 OP SQ L	FSS	GR10q	2.5	E3DASOZ2D28B	E3DASOZ2D28W
DA 1X38W TC-DDEL HF CL1 E3 OP SQ L	FSS	GR10q	2.5	E3DASOZ2D38B	E3DASOZ2D38W
Opal diffuser with visor - square large					
DA VIS 2X18W TC-DEL HF CL1 OP SQ L	FSD	G24q-2	2.1	DASOVZ218B	DASOVZ218W
DA VIS 2X18W TC-DEL HFD CL1 OP SQ L	FSD	G24q-2	2.1	DASOVCLD218B	DASOVCLD218W
DA VIS 2X26W TC-DEL HF CL1 OP SQ L	FSQ	G24q-3	2.1	DASOVZ226B	DASOVZ226W
DA VIS 2X26W TC-DEL HFD CL1 OP SQ L	FSQ	G24q-3	2.1	DASOVCLD226B	DASOVCLD226W
DA VIS 1X28W TC-DDEL HF CL1 OP SQ L	FSS	GR10q	1.85	DASOVZ2D28B	DASOVZ2D28W
DA VIS 1X38W TC-DDEL HF CL1 OP SQ L	FSS	GR10q	2	DASOVZ2D38B	DASOVZ2D38W

Description	Icos Code	Socket	Wt (Kg)	Cat.No. Black	White
Opal diffuser with visor - square large - emergency versions					
DA VIS 1X28W TC-DDEL HF CL1 E3 OP SQ L	FSS	GR10q	2.65	E3DASOVZ2D28B	E3DASOVZ2D28W
DA VIS 1X38W TC-DDEL HF CL1 E3 OP SQ L	FSS	GR10q	2.65	E3DASOVZ2D38B	E3DASOVZ2D38W
Opal diffuser with grille - square large					
DA GRIL 2X18W TC-DEL HF CL1 OP SQ L	FSD	G24q-2	2.1	DASOGZ218B	DASOGZ218W
DA GRIL 2X18W TC-DEL HFD CL1 OP SQ L	FSD	G24q-2	2.1	DASOGCLD218B	DASOGCLD218W
DA GRIL 2X26W TC-DEL HF CL1 OP SQ L	FSD	G24q-3	2.1	DASOGZ226B	DASOGZ226W
DA GRIL 2X26W TC-DEL HFD CL1 OP SQ L	FSD	G24q-3	2.1	DASOGCLD226B	DASOGCLD226W
DA GRIL 1X28W TC-DDEL HF CL1 OP SQ L	FSS	GR10q	1.85	DASOGZ2D28B	DASOGZ2D28W
DA GRIL 1X38W TC-DDEL HF CL1 OP SQ L	FSS	GR10q	2	DASOGZ2D38B	DASOGZ2D38W
Opal diffuser with grille - square large - emergency versions					
DA GRIL 1X28W TC-DDEL HF CL1 E3 OP SQ L	FSS	GR10q	2.65	E3DAROGZ2D28B	E3DAROGZ2D28W
DA GRIL 1X38W TC-DDEL HF CL1 E3 OP SQ L	FSS	GR10q	2.65	E3DAROGZ2D38B	E3DAROGZ2D38W
Prismatic diffuser - square large					
DA 2X18W TC-DEL HF CL1 PR SQ L	FSD	G24q-2	1.95	DASpz218B	DASpz218W
DA 2X18W TC-DEL HFD CL1 PR SQ L	FSD	G24q-2	1.95	DASpCLD218B	DASpCLD218W
DA 2X26W TC-DEL HF CL1 PR SQ L	FSD	G24q-3	1.95	DASpz226B	DASpz226W
DA 2X26W TC-DEL HFD CL1 PR SQ L	FSD	G24q-3	2.1	DASpCLD226B	DASpCLD226W
DA 1X28W TC-DDEL HF CL1 PR SQ L	FSS	GR10q	1.7	DASpz2D28B	DASpz2D28W
DA 1X38W TC-DDEL HF CL1 PR SQ L	FSS	GR10q	1.85	DASpz2D38B	DASpz2D38W
Prismatic diffuser - square large - emergency versions					
DA 1X28W TC-DDEL HF CL1 E3 PR SQ L	FSS	GR10q	2.5	E3DASpz2D28B	E3DASpz2D28W
DA 1X38W TC-DDEL HF CL1 E3 PR SQ L	FSS	GR10q	2.5	E3DASpz2D38B	E3DASpz2D38W

HF - High Frequency, HFD - High Frequency Dimmable Digital

Loire

Description	Ilcos Code	Socket	Wt (Kg)	Cat.No.	
				Black	White
Polycarbonate diffuser with grille - large					
LO GRIL 2X18W TC-DEL HF CL1 PC L IP65	FSD	G24q-2	2.25	LOROGZ218B	LOROGZ218W
LO GRIL 1X28W TC-DDEL HF CL1 PC L IP65	FSS	GR10q	2.6	LOROGZ2D28B	LOROGZ2D28W
LO GRIL 1X38W TC-DDEL HF CL1 PC L IP65	FSS	GR10q	1.95	LOROGZ2D38B	LOROGZ2D38W
Polycarbonate diffuser with grille - large - emergency versions					
LO GRIL 1X28W TC-DDEL HF CL1 E3 PC L IP65	FSS	GR10q	2.65	E3LOROGZ2D28B	E3LOROGZ2D28W
LO GRIL 1X38W TC-DDEL HF CL1 E3 PC L IP65	FSS	GR10q	2.65	E3LOROGZ2D38B	E3LOROGZ2D38W
Glass diffuser - large					
LO 2X18W TC-DEL HF CL1 GL L IP20	FSD	G24q-2	3.35	LORGZ218B	LORGZ218W
LO 1X28W TC-DDEL HF CL1 GL L IP20	FSS	GR10q	2.85	LORGZ2D28B	LORGZ2D28W
LO 1X38W TC-DDEL HF CL1 GL L IP20	FSS	GR10q	3.05	LORGZ2D38B	LORGZ2D38W
Glass diffuser - large - emergency versions					
LO 1X28W TC-DDEL HF CL1 E3 GL L IP20	FSS	GR10q	3.75	E3LORGZ2D28B	E3LORGZ2D28W
LO 1X38W TC-DDEL HF CL1 E3 GL L IP20	FSS	GR10q	3.75	E3LORGZ2D38B	E3LORGZ2D38W
Glass diffuser with visor - large					
LO VIS 2X18W TC-DEL HF CL1 GL L IP20	FSD	G24q-2	3.6	LORGVZ218B	LORGVZ218W
LO VIS 1X28W TC-DDEL HF CL1 GL L IP20	FSS	GR10q	3.1	LORGVZ2D28B	LORGVZ2D28W
LO VIS 1X38W TC-DDEL HF CL1 GL L IP20	FSS	GR10q	3.3	LORGVZ2D38B	LORGVZ2D38W
Glass diffuser with visor - large - emergency versions					
LO VIS 1X28W TC-DDEL HF CL1 E3 GL L IP20	FSS	GR10q	4	E3LORGVZ2D28B	E3LORGVZ2D28W
LO VIS 1X38W TC-DDEL HF CL1 E3 GL L IP20	FSS	GR10q	4	E3LORGVZ2D38B	E3LORGVZ2D38W
Glass diffuser with grille - large					
LO GRIL 2X18W TC-DEL HF CL1 GL L IP20	FSD	G24q-2	3.6	LORGGZ218B	LORGGZ218W
LO GRIL 1X28W TC-DDEL HF CL1 GL L IP20	FSS	GR10q	3.1	LORGGZ2D28B	LORGGZ2D28W
LO GRIL 1X38W TC-DDEL HF CL1 GL L IP20	FSS	GR10q	3.3	LORGGZ2D38B	LORGGZ2D38W
Glass diffuser with grille - large - emergency versions					
LO GRIL 1X28W TC-DDEL HF CL1 E3 GL L IP20	FSS	GR10q	4	E3LORGGZ2D28B	E3LORGGZ2D28W
LO GRIL 1X38W TC-DDEL HF CL1 E3 GL L IP20	FSS	GR10q	4	E3LORGGZ2D38B	E3LORGGZ2D38W

HF - High Frequency

The Quick Fix Bracket can be ordered as an individual item

Spare	
QUICK FIX BRACKET	AMQFB

THORN

Lighting people and places

Thorn Lighting Limited

UK Sales desk -

Orders/Stock Enquiries

Tel: 08701 610 610

Fax: 08701 610 611

Regional Offices

& Lighting Design Centres

Tel: 08701 610 710

Fax: 08701 610 711

Eastern & London Projects

Silver Screens, Elstree Way, Borehamwood,
Hertfordshire, WD6 1FE

Tel: 08701 610 710

Fax: 08701 610 711

Southern & Western Projects

16 Columbus Walk, Atlantic Wharf,
Cardiff, Wales CF10 4TL

Tel: 08701 610 710

Fax: 08701 610 711

Northern Projects

The Towers, Wilmslow Road, Didsbury,
Manchester M20 2SE

Tel: 08701 610 710

Fax: 08701 610 711

South East and South West Wholesale

Silver Screens, Elstree Way, Borehamwood,
Hertfordshire, WD6 1FE

Tel: 08701 610 710

Fax: 08701 610 711

Northern & Midlands Wholesale

Trading Estate, Spennymoor,
Co. Durham DL16 7UR

Tel: 08701 610 710

Fax: 08701 610 711

Scotland

Hamilton Business Centre, Caird Park,
Hamilton, Lanarkshire ML3 0QB

Tel: 08701 610 710

Fax: 08701 610 711

Northern Ireland

Building 3 Lesley Office Park,
393 Hollywood Road, Belfast BT4 2LS

Tel: 08701 610 710

Fax: 08701 610 711

Outdoor Lighting

The Towers, Wilmslow Road, Didsbury,
Manchester M20 2SE

Tel: 0161 445 2719

Fax: 0161 448 8015

e-mail: enquiries.outdoor@thornlight.com

Airfield Lighting

Silver Screens, Elstree Way, Borehamwood,
Hertfordshire, WD6 1FE

Tel: 020 8732 9804

Fax: 020 8732 9803

E-mail: airfield@thornlight.com

Website: www.thornairfield.com

Ireland

320 Harold's Cross Road, Dublin 6W

Tel: (353) 1 4922 877

Fax: (353) 1 4922 724

E-mail: enq.dublin@thornlight.com

International Sales

Silver Screens, Elstree Way, Borehamwood,
Hertfordshire, WD6 1FE

Tel: 020 8732 9802

Fax: 020 8732 9803

E-mail: international.sales@thornlight.com

Thorn Lighting Ltd Dubai

Al Shoala Building, Office 301,
Block E, PO Box 1200, Deira, Dubai, UAE

Tel: (971) 4 2940181

Fax: (971) 4 2948838

E-mail: lluae@emirates.net.ae

Thorn Gulf LLC

Al Shoala Building, Office 301/2,
Block E, PO Box 1200, Deira, Dubai, UAE

Tel: (971) 4 2948938

Fax: (971) 4 2948838

E-mail: thorn@emirates.net.ae

Spare Parts

Tel: 0191 301 3131

Fax: 0191 301 3038

E-mail: spares@thornlight.com

Technical Support

Tel: 0870 600 8111

Fax: 0191 301 3907

E-mail: technical@thornlight.com

Brochureline Answering Service

Brochures on specific products/ranges

Tel: 020 8732 9898

Fax: 020 8732 9899

E-mail: brochures@thornlight.com

Other Offices in:

Australia, Austria, China, Czech Republic,
Denmark, Estonia, Finland, France,
Hong Kong, Hungary, Italy, Latvia, Lithuania,
New Zealand, Norway, Poland, Russia,
Singapore, Sweden and UAE

www.thornlighting.co.uk

Thorn Lighting is constantly developing and improving its products. All descriptions, illustrations, drawings and specifications in this publication present only general particulars and shall not form part of any contract. The right is reserved to change specifications without prior notification or public announcement. All goods supplied by the company are supplied subject to the company's General Conditions of Sale, a copy of which is available on request. All measurements are in millimetres and weights in kilograms unless otherwise stated.

Publication No: 347(UK) Publication Date: 2/05



Member of The Lighting
Industry Federation



ISO 9001:2000
Reg: 2916/0
Manufacturing & Distribution