

UK Installation Instructions
DE Montageanleitung
CZ Montážní návod
DK Monteringsvejledning
EE Paigaldusjuhend

FI Asennusohje
FR Notice de montage
HU Szerelési útmutató
IT Montavimo Instrukcijos
LT Montavimo Instrukcijos

LV Instalācijas instrukcija
NO Monteringsanvisning
PL Instrukcja montażu
SE Installationsanvisning
RU Инструкция по монтажу

230-240V/50-60Hz
 CII
 IP 44



TCI I_{max}=500mA

TW 1,5mm² 10A

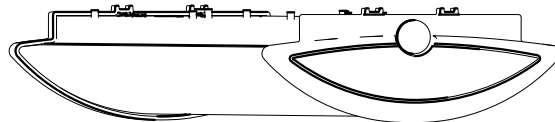

- A. Prisma LED HF 2000 FR L840 (+TW)
- B. Prisma LED HFI-X 2000 FR L840 (+TW)
- C. Prisma LED HF 2000 FR SLDMD BASIC L840 (+TW)
- D. Prisma LED HF 4200 FR L840 (+TW)
- E. Prisma LED HFI-X 4200 FR L840 (+TW)
- F. Prisma LED HF 4200 FR SLDMD BASIC L840 (+TW)

	C-C (mm)	L (mm)	kg	+TW kg
A	560	642	2,0	2,1
B	560	642	2,0	2,1
C	645	722	2,1	2,2
D	770	902	3,1	3,2
E	770	902	3,1	3,2
F	795	972	3,2	3,3

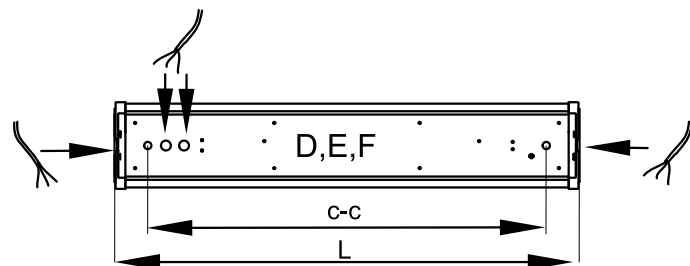
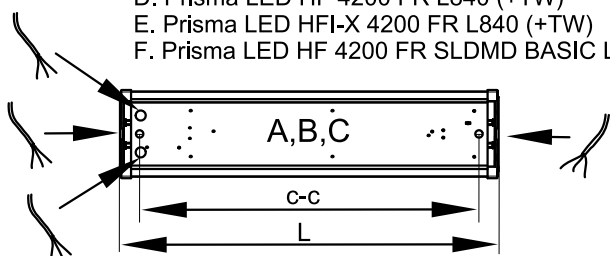

1

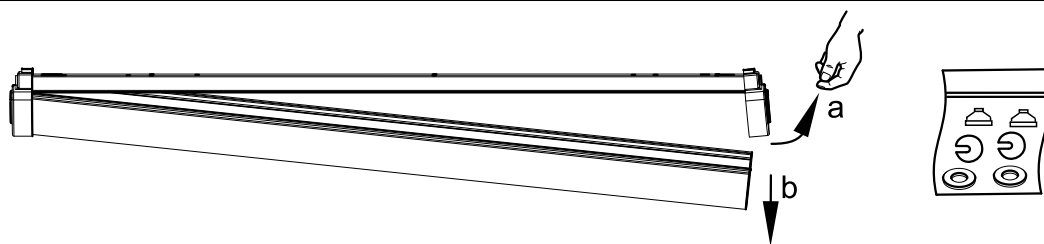

2

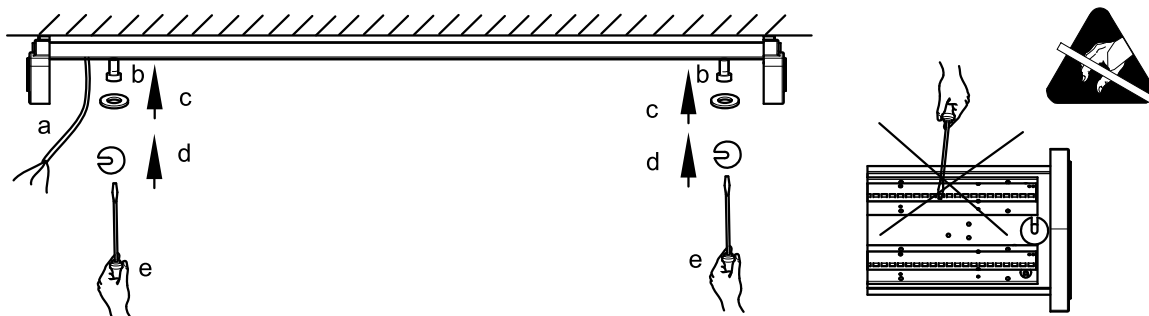

3

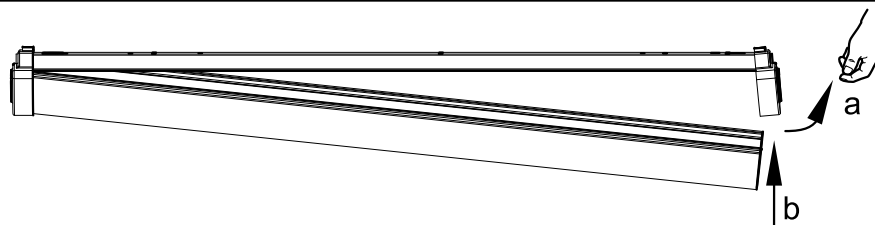

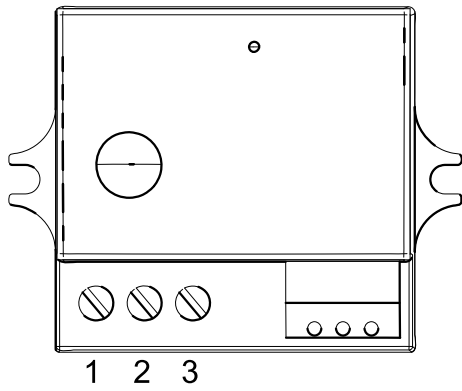

SLDMD SENSOR



***Test mode**
 The implemented test mode enables to check the functionality after installation.
 By turning the middle positioned potentiometer completely to the left side, a hold time of approx. 2 seconds will be set.

Default settings

-  1. Sensitivity 20-100% (max)
-  2. Hold time 2*-1200 sec (max)
-  3. Brightness 1-1000 Lux (max)

DETECTION FIELD

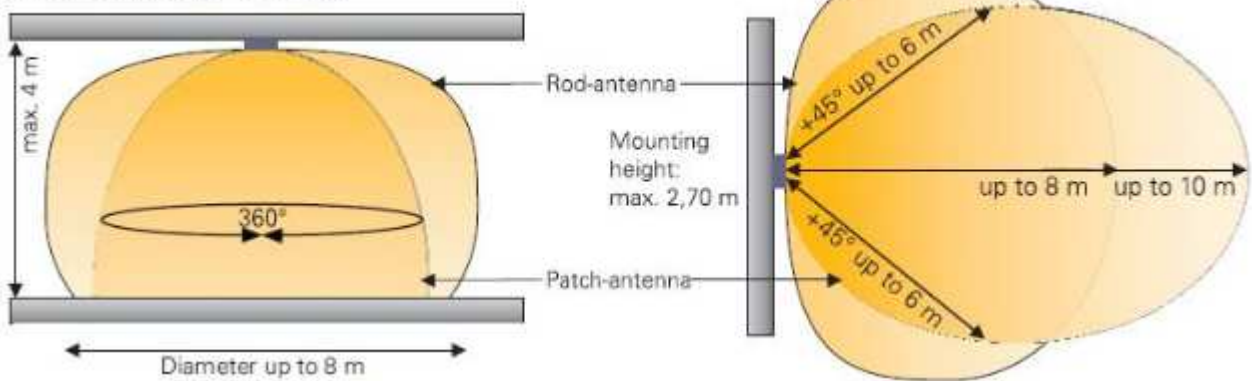

HF/SENSOR

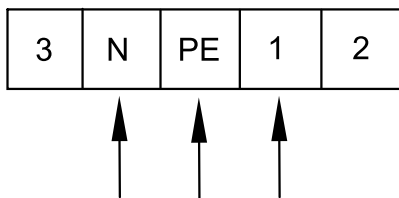

HFI-X

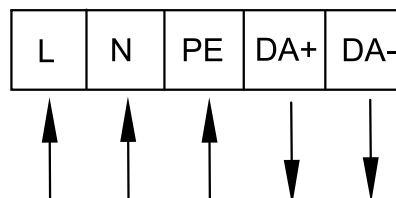

SWITCH DIM

